

ATE1-127 TEC Modules

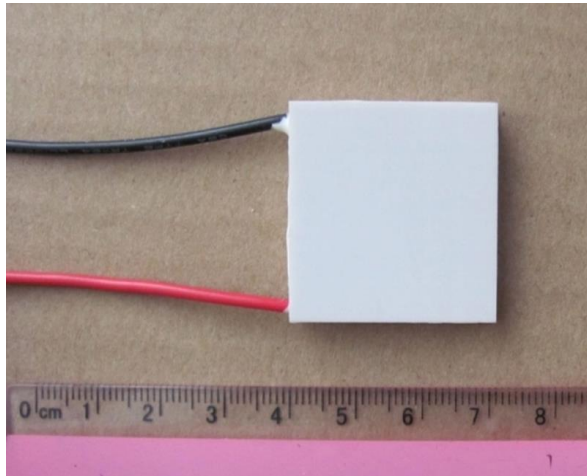

Figure 1.1. The Photo of Actual ATE1-127

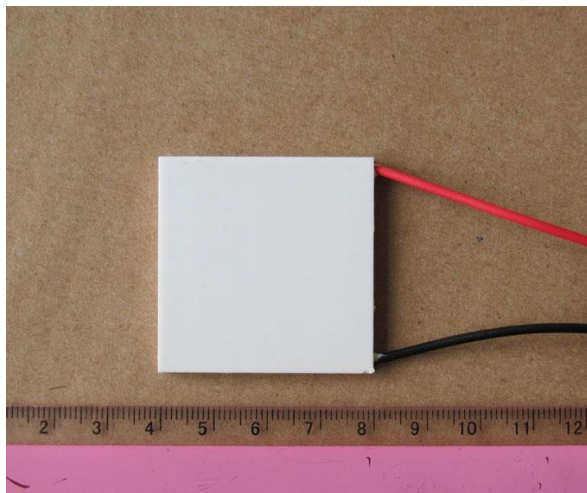

Figure 1.2. The Photo of Actual ATE1-127

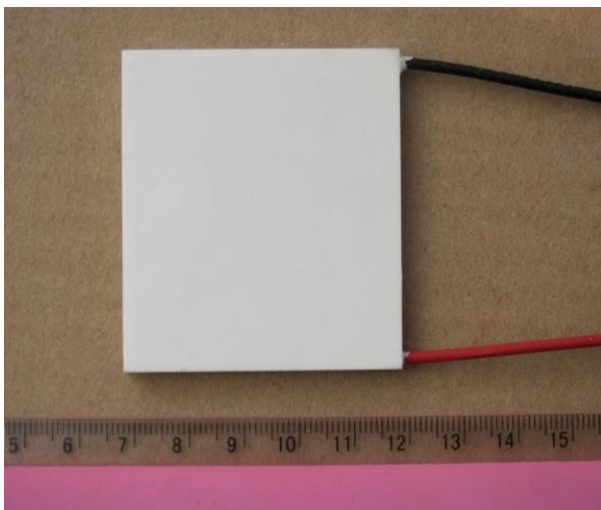

Figure 1.3. The Photo of Actual ATE1-127

FEATURES

- Maximum Input Voltage: 15.4V
- Low Cost
- Long Life Time
- 100 % lead (Pb)-free and RoHS compliant

APPLICATIONS

Regulate the temperature of the target object with high changing speed and stabilize the temperature to a wide range with high precision. Widely used in solid state lasers, optical components, CCD's, IR cameras, bio-tech testing benches, etc.

DESCRIPTIONS

This series of TEC (Thermoelectric Cooler) modules, ATE1-127, has 127 pairs of Peltier elements inside with a maximum voltage of 15.4 Volt, there are several options for maximum current, resulting in different power gratings, as shown in Table 1 below. They are designed for regulating the temperature of the target objects precisely and can be controlled by our TEC controllers to build highly stable and efficient temperature regulating systems. The ATE1-127 series TECs can be used with our thermistors as well to achieve precise and stable temperature sensing.

The ATE1-127 series TECs come in with highly flat bare ceramic surfaces on the both sides, they can be mounted onto flat metal surfaces by inserting thin layers of thermally conductive filler materials, the so-called thermal pads, or placing a thin layer of thermal paste. When mounting, make sure that proper pressure is applied constantly to keep good thermal contacting between the metal and the TEC plates, minimizing thermal resistance between them.

The TECs can withstand strong orthogonal forces applied to the surface, but very vulnerable to tangent forces, especially shocking tangent forces. A small shocking tangent force can cause the Peltier elements crack inside. The crack may not cause operation problem initially, but it will grow with time, causing the TEC resistance to increase slowly, by the end, the TEC will stop operating.

In the part number, for example, ATE1-127-2ASH, "1A" indicate the maximum current allowed for entering the TEC module. "S" represents sealed version and "H" stands for high operating temperature, up to 200 °C. All of them can achieve a maximum temperature difference, DT_{MAX} , of 68 °C.

There are two different operating temperature ranges to choose. One is $-55\text{ °C}\sim 85\text{ °C}$ for the TECs, whose part number is without an "H" and the other is $-55\text{ °C}\sim 200\text{ °C}$ for the TECs, whose part number is ended with an "H".

The ATE1-127 TECs come with 2 insulated lead wires. The positive wire is in red color, and the negative wire is of black. The mechanical dimensions are shown in Figure 10, Figure 11 and Table 1.

The TECs, which have the edge area be sealed, are to prevent moisture from getting into the Peltier elements and to extend the life time of the TECs. The advantage of the non-sealed TECs is that the efficiency is higher and can achieve higher maximum temperature difference between the two TEC plates. Figure 1.1, 1.2 and 1.3 show the photos of sealed TECs.

For applications in moisture environments, sealed version is recommended, in order to achieve long life time and high reliability for the system.

For high end applications where good and reliable thermal contacts are needed between the TEC and the target object surfaces, the TEC ceramic surface can be metalized so that the TEC and the target object surfaces can be soldered together.

[CLICK HERE TO BUY NOW](#)

SPECIFICATIONS

Table 1

Part #	I _{MAX} (A)	V _{MAX} (V)	Q _{MAX} (W)	DT _{MAX} (°C)	Dimension (mm)				1-4 PCs	5-24 PCs	25-99 PCs	≥100 PCs	Note
					L _c	L _h	W	H					
ATE1-127-3A	3	15.4	20	66	30		30	3.60	\$23.69	\$22.50	\$21.90	\$21.20	Non-sealed
ATE1-127-3AS	3	15.4	20	65	30		30	3.60	\$23.69	\$22.50	\$21.90	\$21.20	Sealed
ATE1-127-4A	4	15.4	33.4	66	30		30	3.20	\$23.69	\$22.50	\$21.90	\$21.20	Non-sealed
ATE1-127-4AS	4	15.4	33.4	65	30		30	3.20	\$23.69	\$22.50	\$21.90	\$21.20	Sealed
ATE1-127-4B	4	15.4	30	66	40		40	4.10	\$24.69	\$23.50	\$22.90	\$22.20	Non-sealed
ATE1-127-4BS	4	15.4	30	65	40		40	4.10	\$24.69	\$23.50	\$22.90	\$22.20	Sealed
ATE1-127-5A	5	15.4	43	66	30		30	3.20	\$23.69	\$22.50	\$21.90	\$21.20	Non-sealed
ATE1-127-5AS	5	15.4	43	65	30		30	3.20	\$23.69	\$22.50	\$21.90	\$21.20	Sealed
ATE1-127-5B	5	15.4	42.5	66	40		40	3.90	\$24.69	\$23.50	\$22.90	\$22.20	Non-sealed
ATE1-127-5BS	5	15.4	42.5	65	40		40	3.90	\$24.69	\$23.50	\$22.90	\$22.20	Sealed
ATE1-127-6AS	6	15.4	50.0	67	30		30	2.80	\$23.69	\$22.50	\$21.90	\$21.20	Sealed
ATE1-127-6BS	6	15.4	51.4	66	40		40	3.80	\$24.69	\$23.50	\$22.90	\$22.20	Sealed
ATE1-127-7AS	7	15.4	60	66	40		40	3.50	\$24.69	\$23.50	\$22.90	\$22.20	Sealed
ATE1-127-8AS	8	15.4	68.9	66	40		40	3.50	\$24.69	\$23.50	\$22.90	\$22.20	Sealed
ATE1-127-8BS	8	15.4	69	66	50		50	4.60	\$28.41	\$27.80	\$27.20	\$26.60	Sealed
ATE1-127-9AS	9.5	15.4	80	65	40		40	3.20	\$28.41	\$27.80	\$27.20	\$26.60	Sealed
ATE1-127-10AS	10	15.4	85	66	40		40	3.40	\$24.69	\$23.50	\$22.90	\$22.20	Sealed
ATE1-127-10BS	10	15.4	85	66	50		50	4.20	\$28.41	\$27.80	\$27.20	\$26.60	Sealed
ATE1-127-12A	12	15.4	95	65	40		40	3.20	\$24.69	\$23.50	\$22.90	\$22.20	Non-sealed
ATE1-127-12BS	12	15.4	102	66	50		50	4.00	\$28.41	\$27.80	\$27.20	\$26.60	Sealed
ATE1-127-15AS	15	15.4	126	66	40		40	3.57	\$28.41	\$27.80	\$27.20	\$26.60	Sealed
ATE1-127-18AS	18	15.4	150	65	50		50	3.60	\$28.41	\$27.80	\$27.20	\$26.60	Sealed
ATE1-127-3AH	3	15.4	20	63	30		30	3.55	\$27.2	\$26.5	\$25.9	\$25.2	Non-sealed
ATE1-127-3ASH	3	15.4	25		30		30	3.55	\$27.2	\$26.5	\$25.9	\$25.2	Sealed
ATE1-127-3BH	3	15.4	25	67	40		40	4.80	\$28.2	\$27.5	\$26.9	\$26.2	Non-sealed

ATE1-127-3BSH	3	15.4	25		40		40	4.80	\$28.2	\$27.5	\$26.9	\$26.2	Sealed
ATE1-127-4AH	4	15.4	33.4	63	30		30	3.53	\$27.2	\$26.5	\$25.9	\$25.2	Non-sealed
ATE1-127-4ASH	4	15.4	33.4		30		30	3.53	\$27.2	\$26.5	\$25.9	\$25.2	Sealed
ATE1-127-4BH	4	15.4	35	67	40		40	4.40	\$28.2	\$27.5	\$26.9	\$26.2	Non-sealed
ATE1-127-4BSH	4	15.4	33.6		40		40	4.40	\$28.2	\$27.5	\$26.9	\$26.2	Sealed
ATE1-127-5AH	5	15.4	44.5	63	30		30	3.46	\$27.2	\$26.5	\$25.9	\$25.2	Non-sealed
ATE1-127-5ASH	5	15.4	42		30		30	3.46	\$27.2	\$26.5	\$25.9	\$25.2	Sealed
ATE1-127-5BH	5	15.4	44.5	67	40		40	4.20	\$28.2	\$27.5	\$26.9	\$26.2	Non-sealed
ATE1-127-6AH	6	15.4	53.3		40		40	4.09	\$28.2	\$27.5	\$26.9	\$26.2	Non-sealed
ATE1-127-6ASH	6	15.4	53.3	67	40		40	4.09	\$28.2	\$27.5	\$26.9	\$26.2	Sealed
ATE1-127-7BSH	7	15.4	58.8	68	50		50	5.50	\$32.1	\$31.4	\$30.7	\$30.0	Sealed
ATE1-127-8AH	8	15.4	71	67	40		40	3.70	\$28.2	\$27.5	\$26.9	\$26.2	Non-sealed
ATE1-127-8ASH	8	15.4	67.2		40		40	3.70	\$28.2	\$27.5	\$26.9	\$26.2	Sealed
ATE1-127-8BSH	8	15.4	67.2	68	50		50	5.20	\$32.1	\$31.4	\$30.7	\$30.0	Sealed
ATE1-127-9ASH	9	15.4	75.6		50		50	4.95	\$32.1	\$31.4	\$30.7	\$30.0	Sealed
ATE1-127-10ASH	10	15.4	84	67	40		40	3.65	\$28.2	\$27.5	\$26.9	\$26.2	Sealed
ATE1-127-10BSH	10	15.4	84	68	50		50	4.80	\$33.1	\$32.4	\$31.7	\$31.0	Sealed
ATE1-127-12BSH	12	15.4	100.8	68	50		50	4.62	\$34.1	\$33.4	\$32.7	\$32.0	Sealed
ATE1-127-15ASH	15	15.4	126	67	40		40	3.75	\$29.2	\$28.5	\$27.9	\$27.2	Sealed
ATE1-127-15BSH	15	15.4	126	68	50		50	4.30	\$34.1	\$33.4	\$32.7	\$32.0	Sealed
ATE1-127-17AH	17	15.4	170	63	50		50	3.74	\$35.1	\$34.4	\$33.7	\$33.0	Non-sealed
ATE1-127-18ASH	18	15.4	170	68	50		50	3.8	\$36.1	\$35.4	\$34.7	\$34.0	Sealed

* DT_{MAX} : DT stands for Differential Temperature between TEC's 2 plates

APPLICATION INFORMATION

As shown in Table 1, the DT_{MAX} , the maximum temperature difference between the 2 TEC plates, is between 63 °C to 68 °C. This is the normal value for a single stage TEC module. When needing a higher DT_{MAX} , 2 or 3 stage TECs must be utilized. Contact us for details.

TEC modules can be used for stabilizing laser chip temperature, to stabilize the wavelength and the working lasing mode, resulting in less or no mode hopping and stable output power.

Inversely, when applying a temperature difference between the TEC 2 plates, electricity can be generated. Thus, the TECs can be called TEGs (thermoelectric Generators).

When designing a thermal system by using TECs, one should choose the TEC module in the following way:

1. To achieve the maximum efficiency, it is essential to minimize the thermal resistance between the TEC plate surface and heat sink surface and between the TEC plate

and the target object surface. The best way to minimize the thermal resistance is to mount the TEC modules' plates to the heat-sink and to the thermal load by soldering them together. This requires metalizing the TEC plate surfaces first. The 2nd best way is to apply a thin layer of thermal paste between the TEC plates and the heat-sink and the target object surfaces. Constant pressure is needed between the TEC plates and heat-sink and the target object surfaces. Thermal pad material, or so called thermal filler pads, can be used to replace the thermal paste. But this may increase the thermal resistance between the TEC plates and the heat-sink and the target object surfaces. Therefore, thermal paste is recommended to be applied between the TEC plates and the heat-sink. One of such products is Type 44 Heat Sink Compound 1/2 FL.OZ. made by Allied. More detail technical data about this material can be found here: <http://www.alliedelec.com/search/productdetail.aspx?SKU=7964390>.. The 3rd best way is to use thermally



conductive epoxy, to glue the TEC surface and the heat-sink and the target object surfaces together. This approach is the least reliable because the epoxy may lose its adhere power as time goes.

2. To achieve high COP, Coefficient of Performance, which is defined as:

$$\text{COP} = \text{thermal power} / \text{electric power},$$

the ratio between the TEC's output thermal power and the input electric power. Apparently, a high COP leads to low power system consumption, thus, high efficiency. The key to achieve high COP is to design the system with a low maximum temperature difference between the 2 TEC plates (the hot side and the cold side), DT. When

the operating DT can be kept to be $\leq 30^\circ\text{C}$, the COP can be as high as 2, a very good result.

3. When the required maximum temperature difference is low, such as $< 30^\circ\text{C}$, a large TEC module can be used to drive small thermal load, resulting in a low DT, thus high COP and efficiency.
4. It is not hard to design in a TEC system, but does require some understanding of heat transfer and a good grasp of your applications.
5. Use the charts provided in Figure 2 to Figure 5 and Figure 6 to Figure 9, to decide which TEC to use, what is the heat needed to be dumped through the heat sink, what is the heat sink temperature, etc.

TYPICAL CHARACTERISTICS
I. $DT_{MAX}=63\text{ }^{\circ}\text{C}$

 Figure 2. Temperature Difference vs. Q_{MAX}

 Figure 3. Temperature Difference vs. I_{MAX}

 Figure 4. V_{MAX} vs. Temperature Difference

Figure 5. C.O.P vs. Temperature Difference

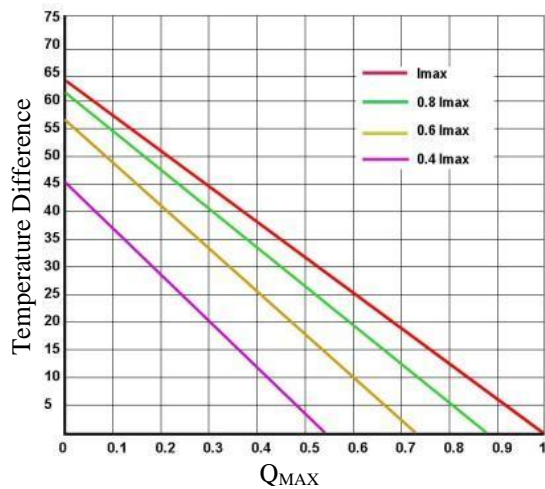
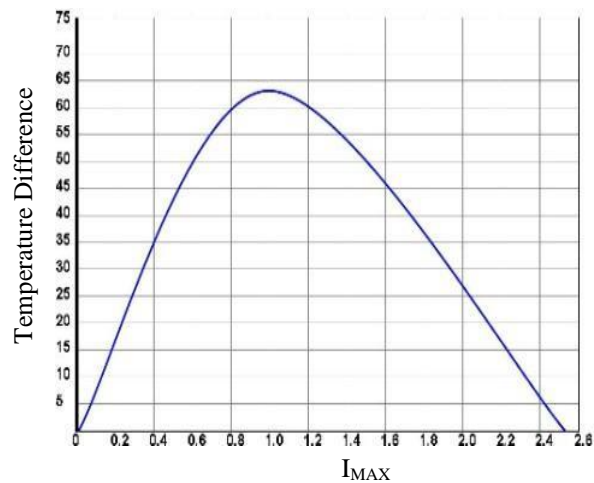
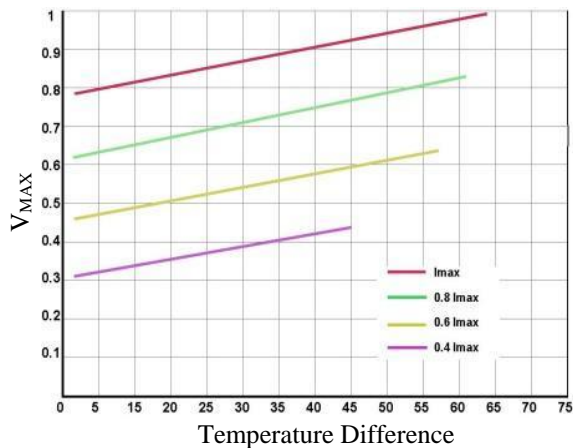
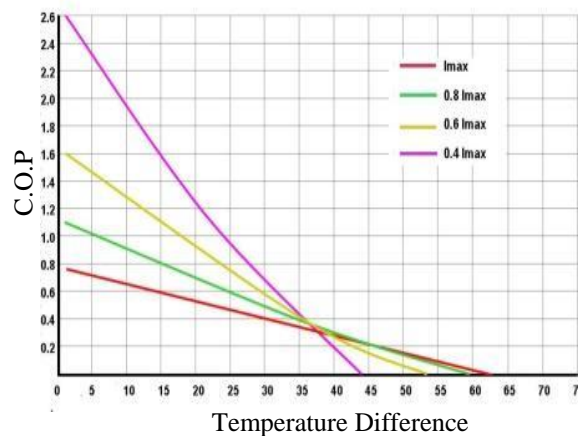
II. $DT_{MAX}=68\text{ }^{\circ}\text{C}$

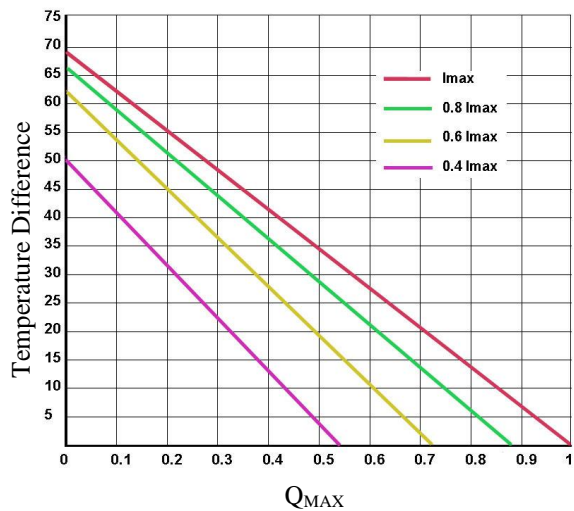

Figure 6. Temperature Difference vs. Q_{MAX}

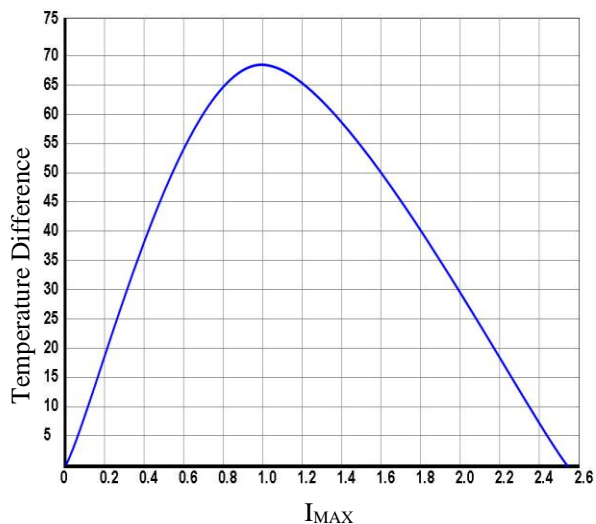

Figure 7. Temperature Difference vs. I_{MAX}

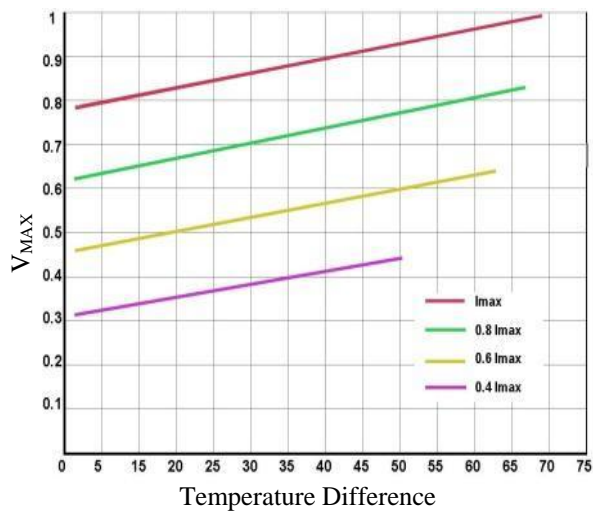

Figure 8. V_{MAX} vs. Temperature Difference

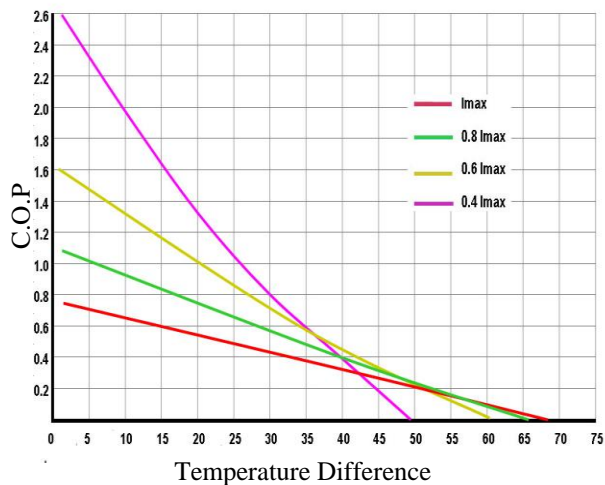

Figure 9. C.O.P vs. Temperature Difference

MECHANICAL DIMENSIONS

The mechanical dimensions of the ATE1-127 are shown below.

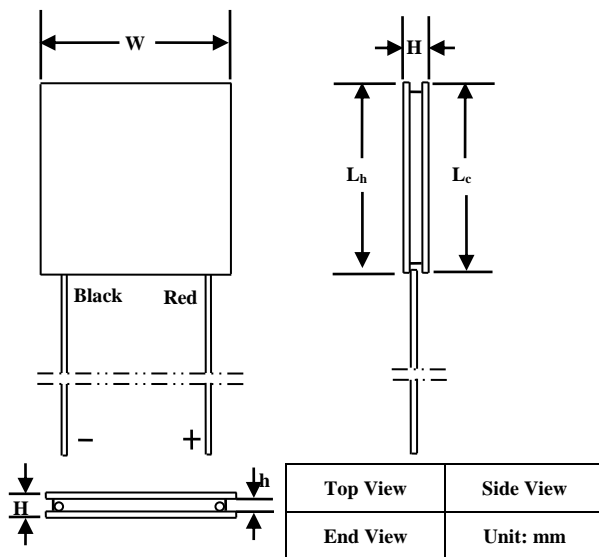

Figure 10. Mechanical Dimensions of Sealed ATE1-127

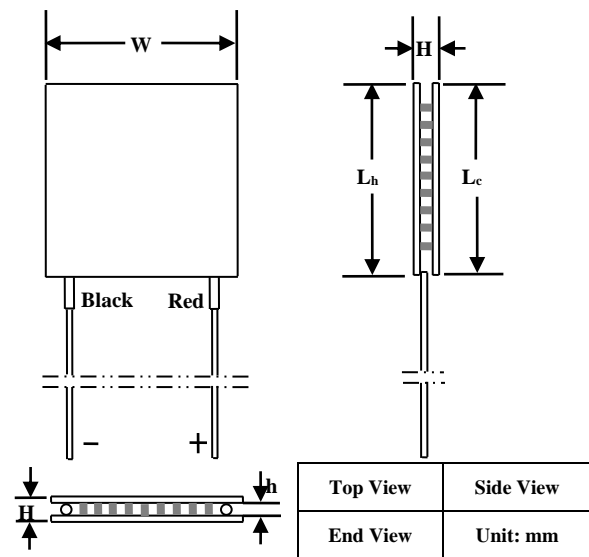

Figure 11. Mechanical Dimensions of Non-sealed ATE1-127

The ATE1-127 series TECs come in square shape, small size, and light weight. The L_c , L_h , W dimensions are the same for the ATE1-127 TECs, only the H dimension varies with different currents, thus different powers, as shown in Table 1.

Note: As Figure 10 shows, when the red lead wire is on the right, then the top surface is the cold side of the TEC.

CAUTIONS

1. Never apply electricity to TEC modules without having heat sinks attached properly.
2. Always keep the current less than I_{MAX} , to avoid thermal run-away disaster.

NOTICE

1. ATI reserves the right to make changes to its products or to discontinue any product or service without notice, and advise customers to obtain the latest version of relevant information to verify, before placing orders, that information being relied on is current and complete.
2. All products are sold subject to the terms and conditions of sale supplied at the time of order acknowledgment, including those pertaining to warranty, patent infringement, and limitation of liability. Testing and other quality control techniques are utilized to the extent ATI deems necessary to support this warranty. Specific testing of all parameters of each device is not necessarily performed, except those mandated by government requirements.
3. Customers are responsible for their applications using ATI components. In order to minimize risks associated with the customers' applications, adequate design and operating safeguards must be provided by the customers to minimize inherent or procedural hazards. ATI assumes no liability for applications assistance or customer product design.
4. ATI does not warrant or represent that any license, either express or implied, is granted under any patent right, copyright, mask work right, or other intellectual property right of ATI covering or relating to any combination, machine, or process in which such products or services might be or are used. ATI's publication of information regarding any third party's products or services does not constitute ATI's approval, warranty or endorsement thereof.
5. IP (Intellectual Property) Ownership: ATI retains the ownership of full rights for special technologies and/or techniques embedded in its products, the designs for mechanics, optics, plus all modifications, improvements, and inventions made by ATI for its products and/or projects.